

# 801

**160 x 200** 2120 x 1720 x 1260 mm

**180 x 200** 2120 x 1920 x 1260 mm

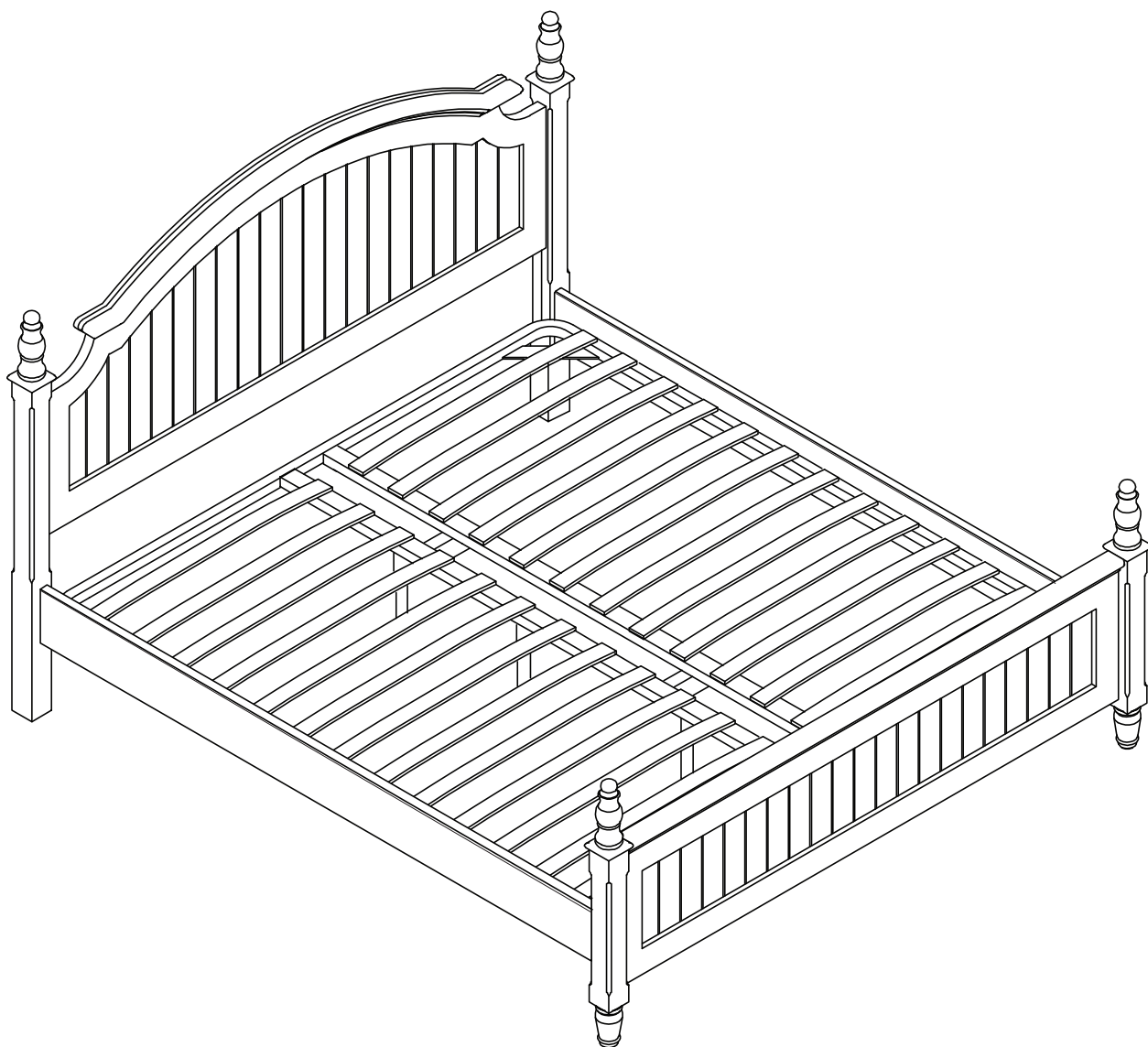

**BEMONDI**

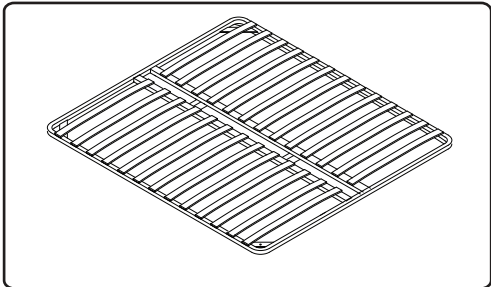

**BED BASE**  
160x200 / 180x200

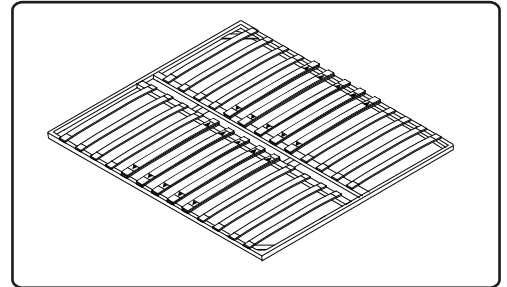

**TWINPACK**  
160x200 / 180x200

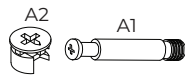
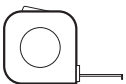
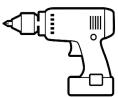
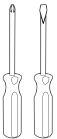
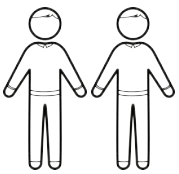
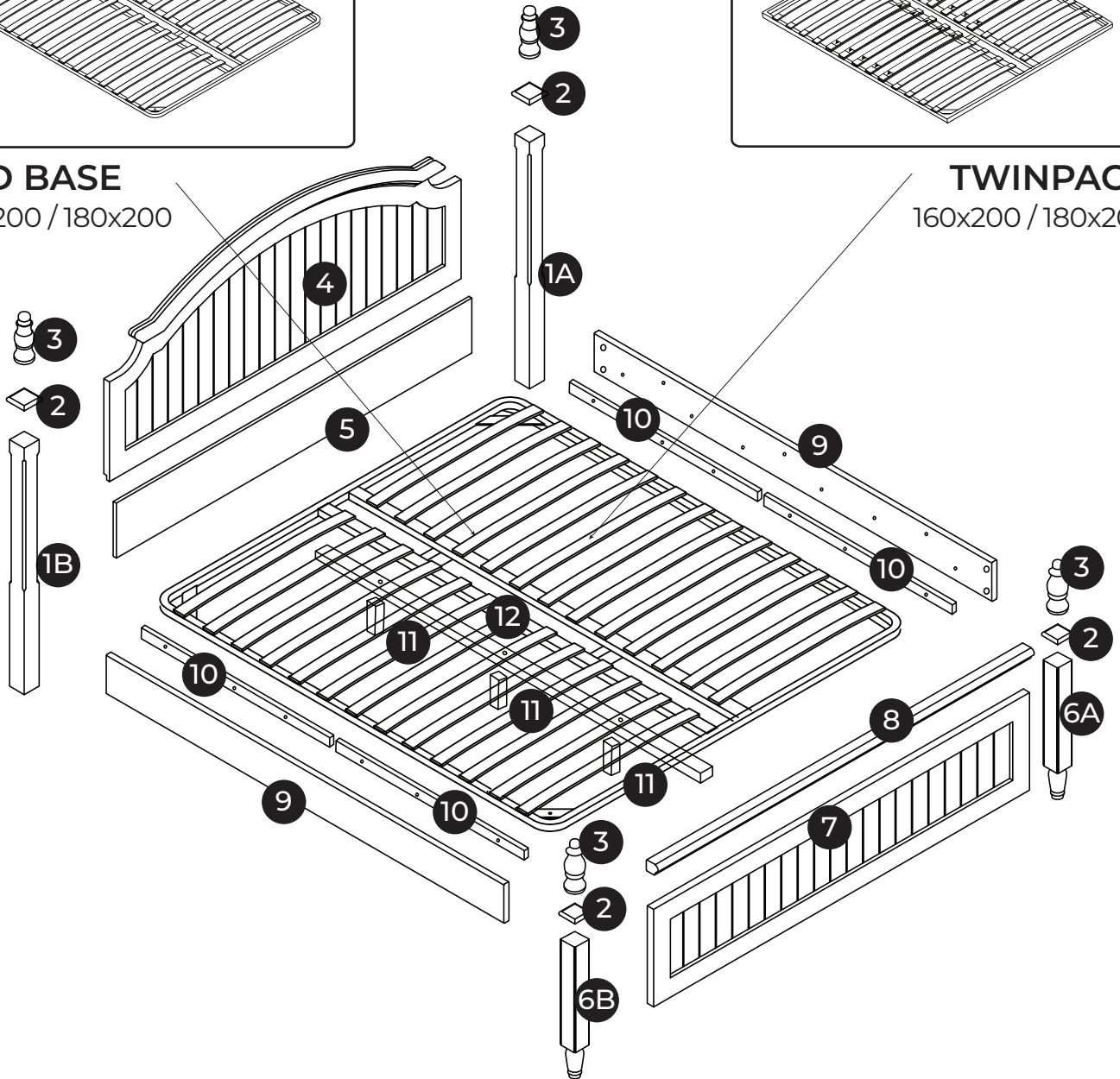

**A** x8  
Ø 15 mm



**B** x24  
Ø 8 x 30 mm



**C** x4  
Ø 8 x 60 mm



**D** x16  
Ø 8 x 70 mm



**E** x16



**F** x16



**G** x12  
Ø 38



**H** x18  
Ø 6 x 50 mm



**I** x14  
Ø 4 x 16 mm



**J** x3  
Ø 8 x 45 mm

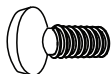

**K** x3  
Ø 20 mm



**L1** x2

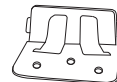

**L2** x2



**M** x6  
Ø 3,5 x 25 mm

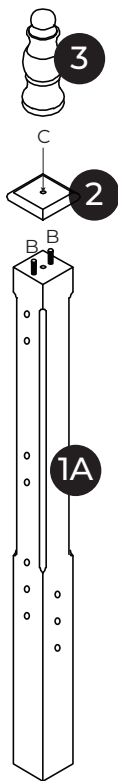

x2

B  x4

C  x2

1

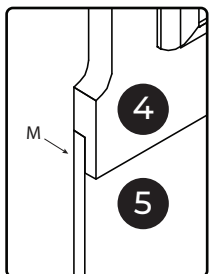

1 x4

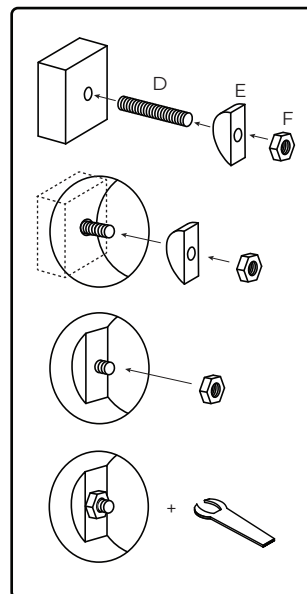
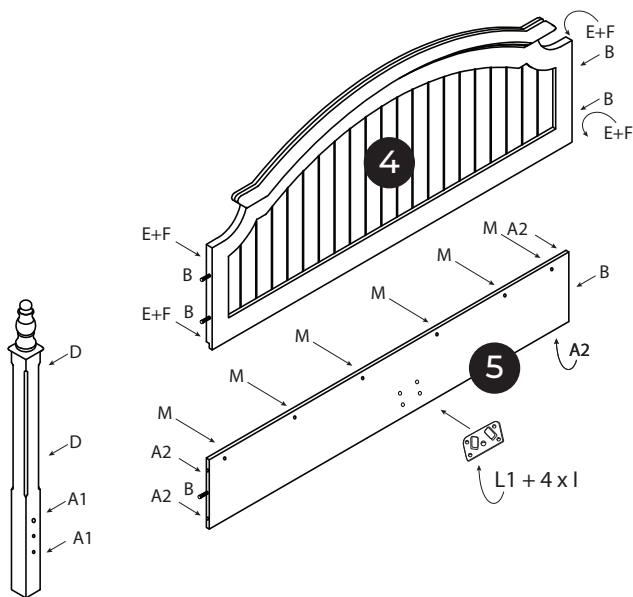
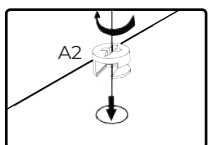
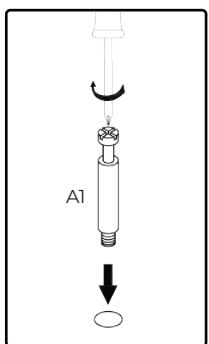

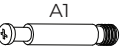
A   x4

B  x6

D  x4

E  x4

F  x4

I  x4

L1  x1

M  x6

2

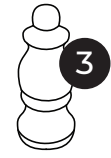

x2

B  x4

C  x2

3

I x4

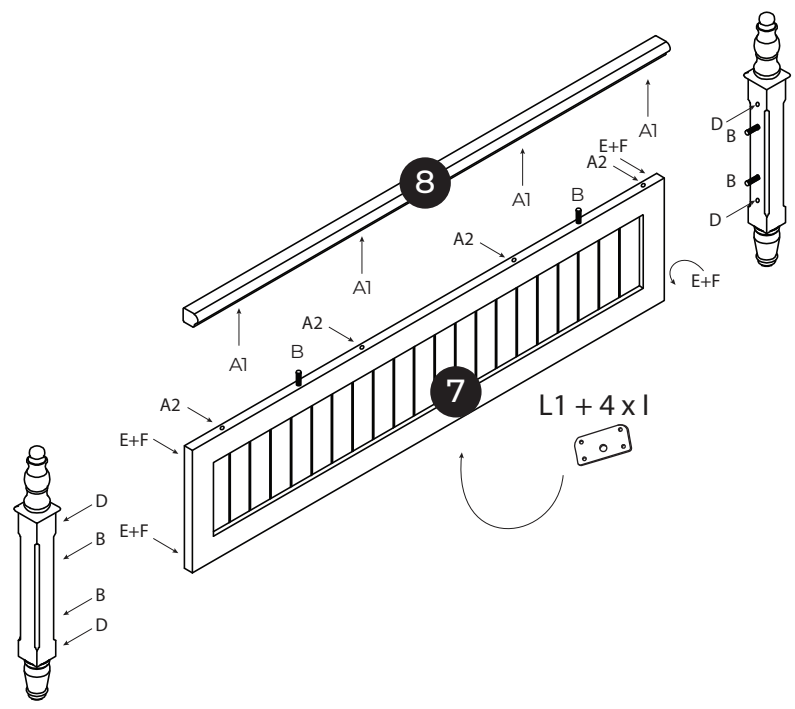

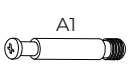

A   x4

B  x6

D  x4

E  x4

F  x4

G  x4

I  x4

L1  x1

4

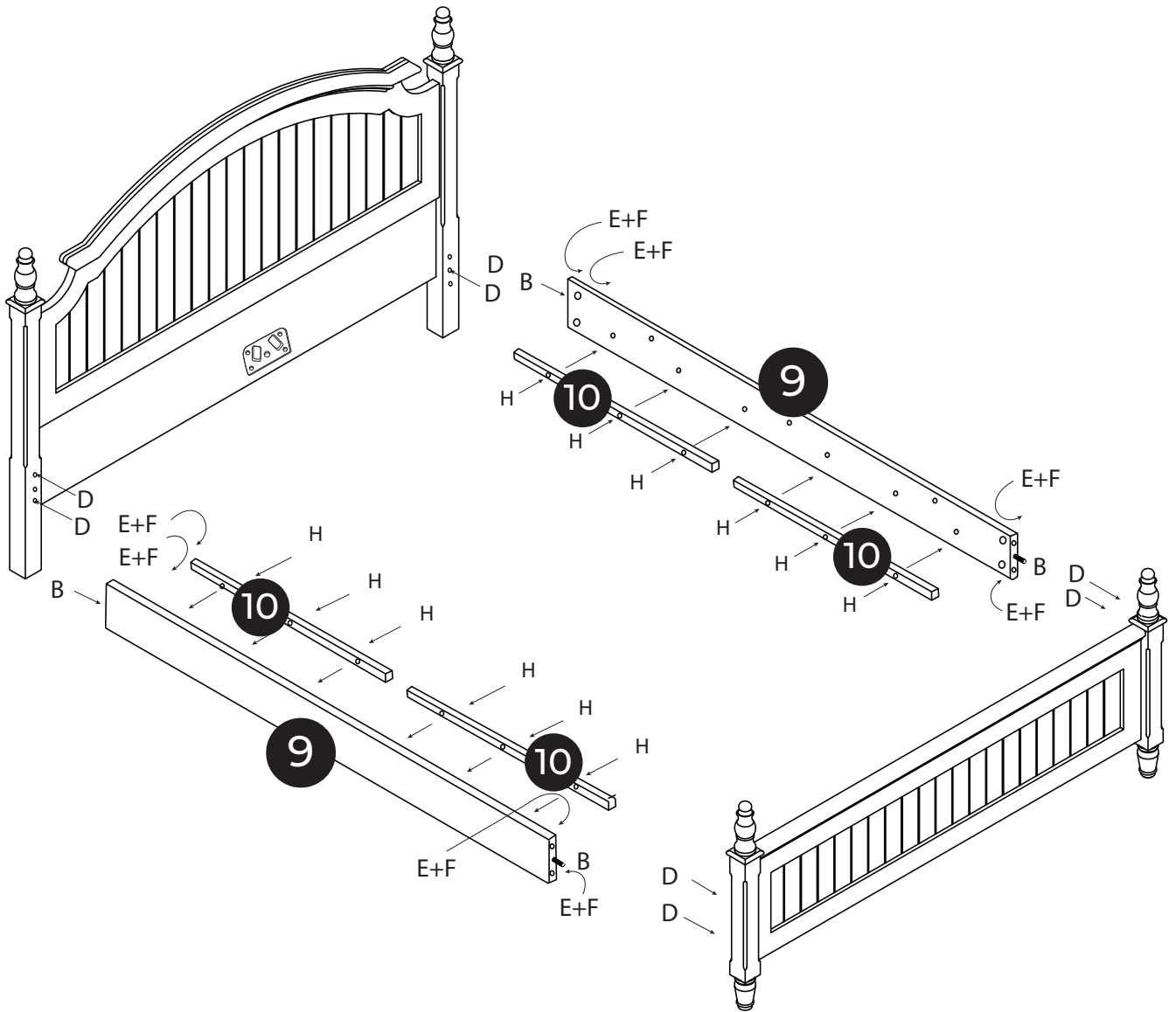
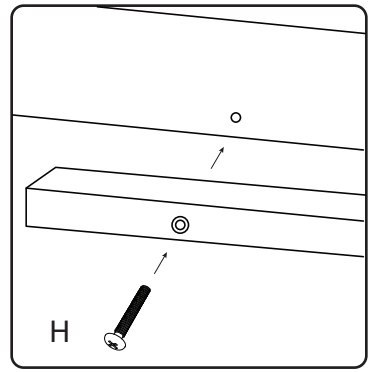

B  x4

D  x8

E  x8

F  x8

G  x8

H  x12

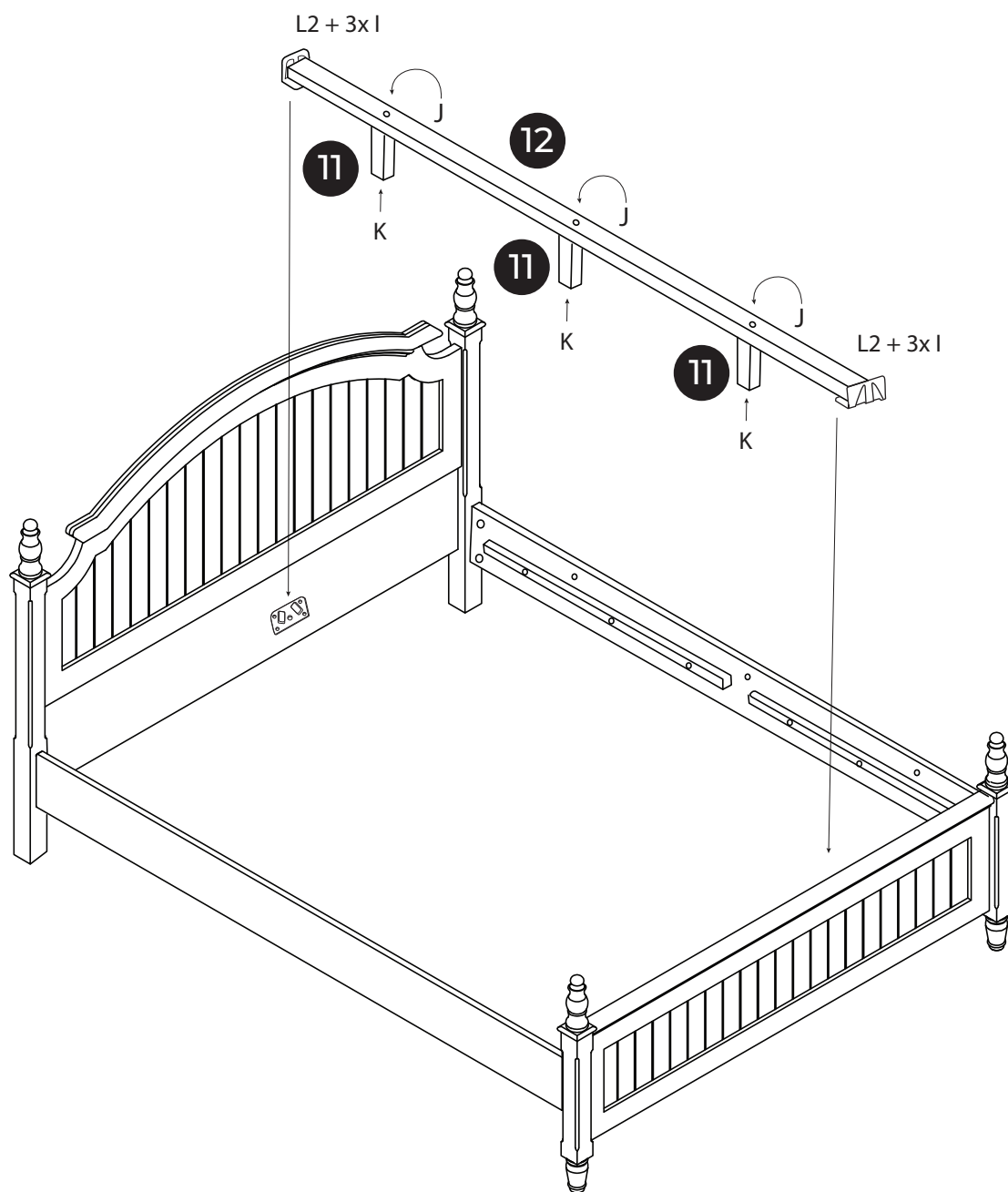
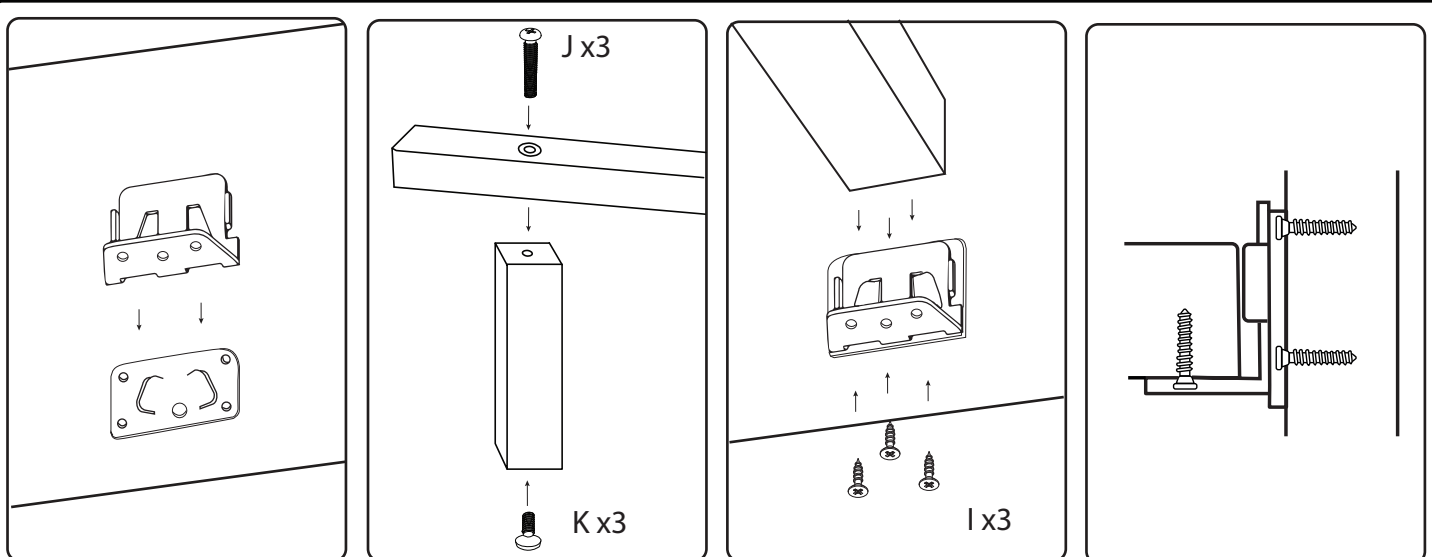

I  x6

J  x3

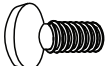
K  x3

L2  x2

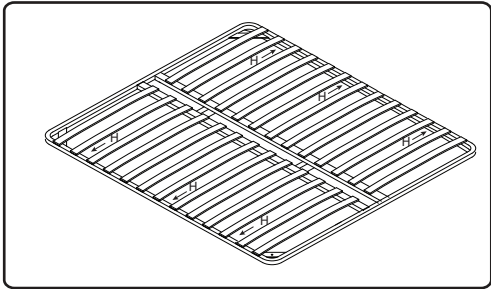

**BED BASE**  
160x200 / 180x200

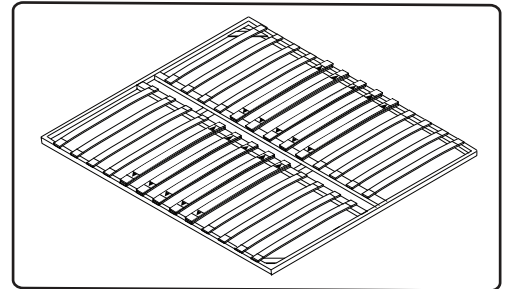

**TWINPACK**  
160x200 / 180x200

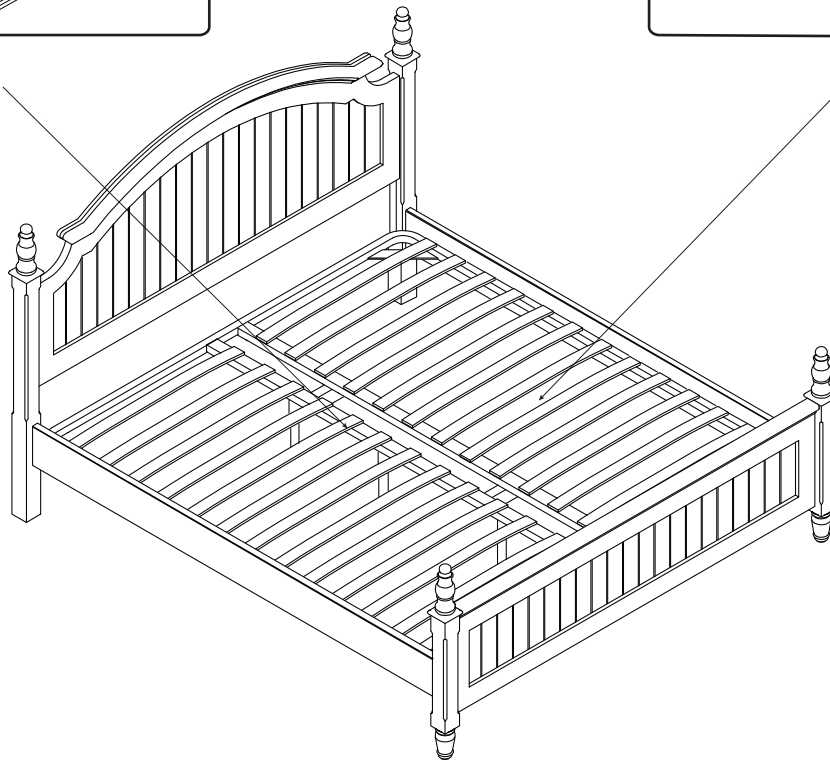

H  x6 **BED BASE**

**7**

**BED BASE**  
160x200 / 180x200

**TWINPACK**  
160x200 / 180x200

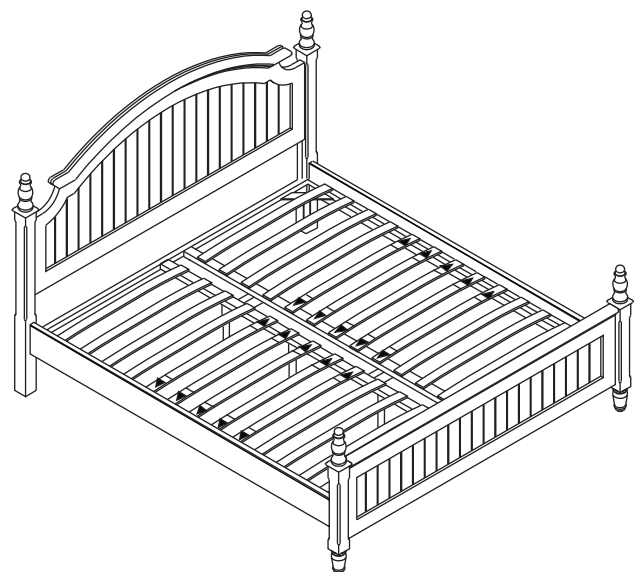
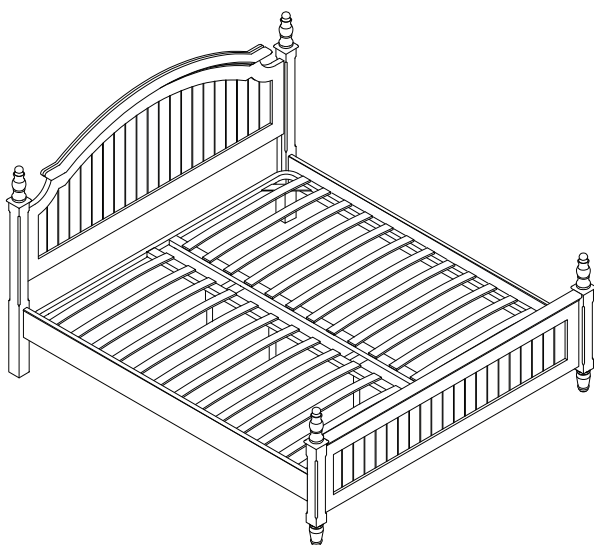

**8**